

High Performance Pressure Sensor



Features

- ➔ Available with Built in Electronic
- ➔ Large choice of connectors & threads
- ➔ High Performance
- ➔ Extreme accuracy : up to 0,05% FS

Applications

- ➔ Aerospace
- ➔ Energy / Nuclear
- ➔ Railway
- ➔ Navy and shipbuilding applications

The PGP220 series is designed for high accuracy pressure measurements, from -1 up to 600bar and above on request. The sensing element is an advanced piezo-resistive pressure module which together with the latest compensation techniques, provides high performance measurements. It is available with low (millivolt) or high level (Vdc, mA) outputs. In the case of transducers, the built-in electronic ensures a correction of the pressure element while delivering an analogue output. Specified at 1kHz @-3dB (higher on request), signal's bandwidth is not affected by these corrections. Wetted parts being all stainless steel, the sensor is compatible with most media used in Industry, even corrosive ones. High accuracy pressure measurements on test benches is one of the main application for the PGP220 series.

Technical specifications

Pressure ranges (FS)	±1bar ; -1/+2bar ; -1/+3bar ; -1/+5bar ; 3bar ; 5bar ; 10bar ; 20bar ; 40bar ; 100bar ; 250bar ; 400bar ; 600bar ; ±14.5PSI ; -14.5/+30PSI ; -14.5/+40PSI ; -14.5/+70PSI ; 8000PSI ; 40PSI ; 70PSI ; 150PSI ; 300PSI ; 500PSI ; 1500PSI ; 3000PSI ; 5000PSI
Type	Absolute ; Gage
Type (for ranges > 40 bar)	Sealed Gage
Safe overload	150% FS
Burst pressure	300% FS
Power supply	8 to 30Vdc
Consumption	< 10mA
Insulation	> 1000 MOhms under 50Vdc at ambient temperature
Output at -100%FS (only for ± range)	0.5Vdc
Output at 0%FS (except ranges ±)	0.5Vdc
Output at 100%FS	4.5Vdc
Zero and sensitivity settings tolerances	±50mV

Technical Specifications

Non linearity and hysteresis combined	±0.1% FS Option : ±0.05% FS
Non repeatability	±0.02% FS typ.
Signal bandwidth	1000Hz @ -3dB
Compensated temperature range	0 to +60°C Option : -25 to +85°C ; -25 to +125°C (Except M12, 723 Receptacles and PVC Cable)
Operating temperature range	-25 to +125°C (-25 to +90°C with M12, 723 Receptacles and PVC Cable)
Combined thermal zero & sensitivity shifts	±0.01% FS/°C
Constant acceleration in linear vibrations	± 0.02% FS/g (frequency 20-2000Hz, 50g max.)
Mechanical shock	100g ½ sinus 1ms
Electrical protection	Protected against polarity inversion
EMC protection	Compliant to EN61000
Electrical connection	DIN 43650 Receptacle - 4 pins Option : Miniature DIN 43650 mPm Receptacle - 4 pins ; Receptacle M12 - 4 pins ; Hermetic MIL-C-26482 - 6 pins Receptacle ; AWG26, Viton Jacketed Shielded Cable Ø3mm, 4 wires ; AWG24 double Shield PVC Cable, 4 wires ; Hermetic M12 4 pins Receptacle ; Binder 723 Receptacle, 5 pins
Mechanical connection	1/4 Gaz A male ; 1/4 NPT male ; M10x1-4h male with 80° internal cone ; M14x1.5-4h male Option : 1/2 Gaz A male (Gauge) ; 1/4 Gaz female ; 7/16-20 UNJF-3A male - MS33656-4 ; M10x1-4h male 120° cone
Material(s) of wetted parts	Stainless Steel 316L ; Stainless Steel 17-4PH ; Stainless steel 15-5PH
Weight	< 120g without cable
Enclosure protection	IP65 for absolute & sealed gage version

Codification

High Performance Pressure Sensor	PGP22	7	S	20bar	A	01	01	A	2	2
Output Signal										
0.5-4.5Vdc unregulated power supply		7								
Material										
Stainless Steels			S							
Range										
Example				20bar						
Type										
Absolute					A					
Gage					G					
Sealed Gage					SG					
Mechanical connection										
M14x1.5-4h male						01				
1/2 Gaz A male (Gauge)						06				
1/4 Gaz A male						07				
1/4 Gaz female						08				
7/16-20 UNJF-3A male - MS33656-4						10				
1/4 NPT male						13				
M10x1-4h male with 80° internal cone						19				
M10x1-4h male 120° cone						21				
Electrical connection										
DIN 43650 Receptacle - 4 pins							01			
Miniature DIN 43650 mPm Receptacle - 4 pins							02			
Hermetic MIL-C-26482 - 6 pins Receptacle							03			
Receptacle M12 - 4 pins							07			
AWG26, Viton Jacketed Shielded Cable Ø3mm, 4 wires							08/1m			
AWG24 double Shield PVC Cable, 4 wires							10/1m			
Hermetic M12 4 pins Receptacle							15			
Binder 723 Receptacle, 5 pins							23			
Compensated temperature range										
0 to +60°C								A		
-25 to +85°C								B		
-25 to +125°C (Except M12, 723 Receptacles and PVC Cable)								C		
Non linearity and hysteresis combined										
±0.1% FS									2	
±0.05% FS									4	
Combined thermal zero & sensitivity shifts										
±0.01% FS/°C										2

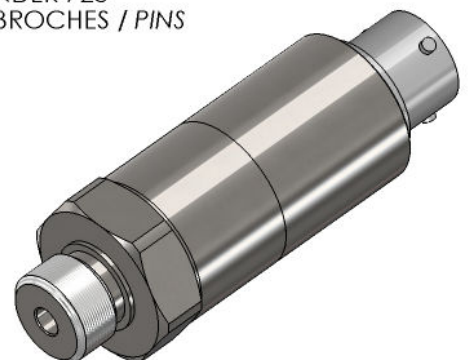
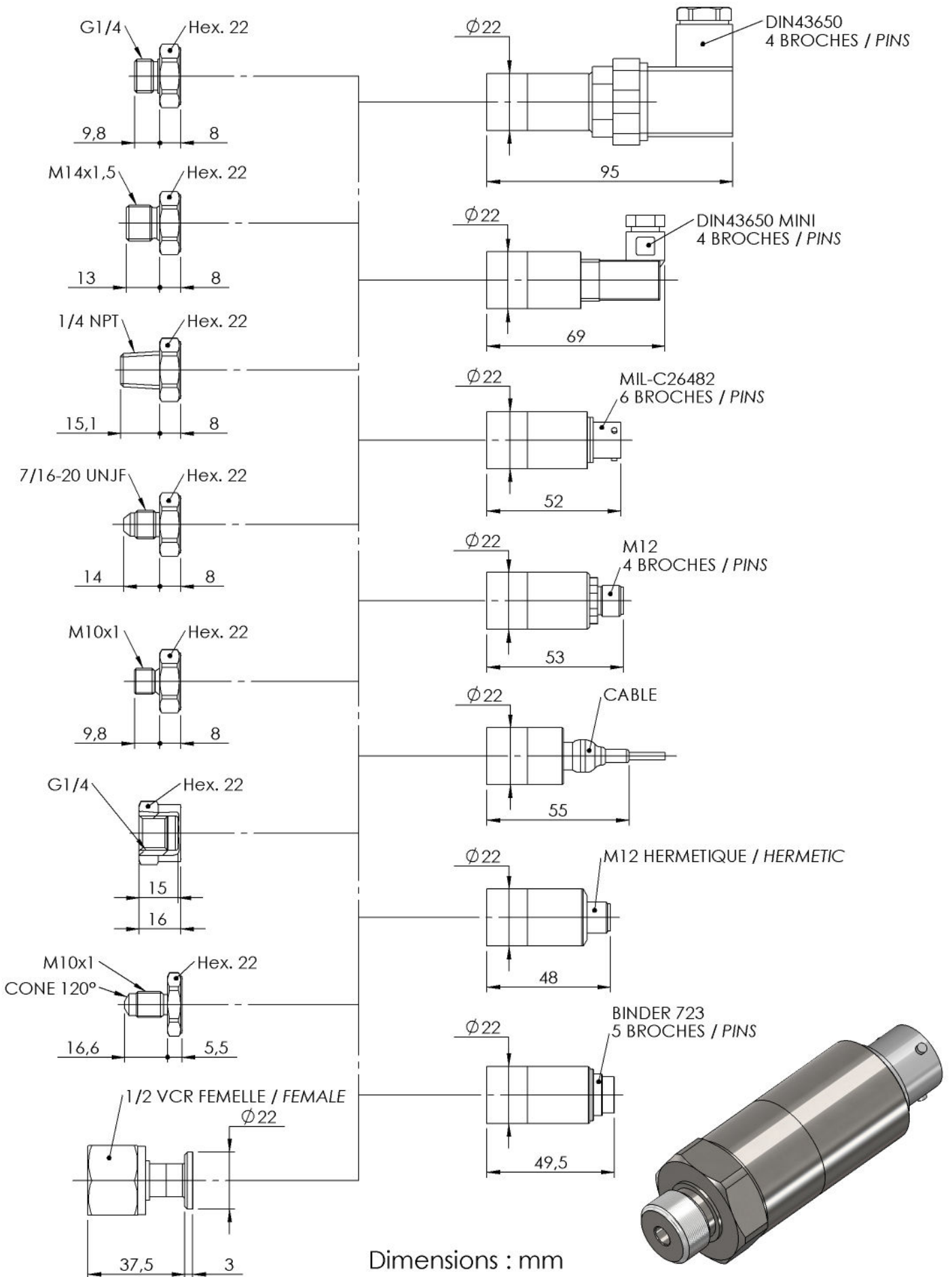

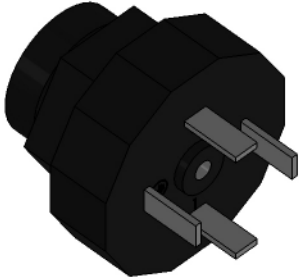

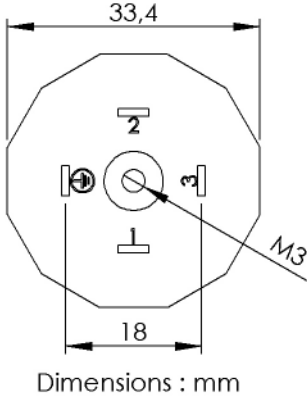

DIN 43650 - 4 PINS	
VOLTAGE OUTPUT	PIN
+ EXCITATION	PIN 1
+ SIGNAL	PIN 2
0 VOLT	PIN 3
SENSOR HOUSING	PIN T



Dimensions : mm

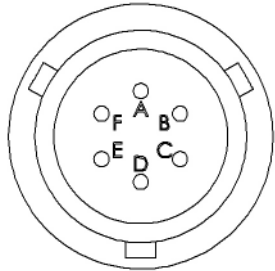

MIL-C26482 - 6 PINS	
VOLTAGE OUTPUT	PIN
+ EXCITATION	PIN A
+ SIGNAL	PIN B
0 VOLT	PIN C
0 VOLT	PIN D
SENSOR HOUSING	PINS E & F

#26 AWG, 4 CONDUCTOR SHIELDED VITON CABLE	
VOLTAGE OUTPUT	CONDUCTOR
+ EXCITATION	RED
+ SIGNAL	GREEN / YELLOW
NC	WHITE
0 VOLT	BLUE / BLACK
SENSOR HOUSING	SHIELD

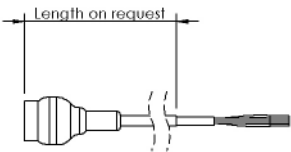

Length on request



DIN MINIATURE 43650 - 4 PINS	
VOLTAGE OUTPUT	PIN
+ EXCITATION	PIN 1
+ SIGNAL	PIN 2
0 VOLT	PIN 3
SENSOR HOUSING	PIN T

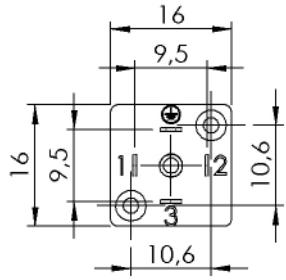

Dimensions : mm

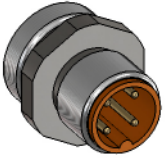

M12 - 4 PINS	
VOLTAGE OUTPUT	PIN
+ EXCITATION	PIN 1
+ SIGNAL	PIN 4
NC	PIN 2
0 VOLT	PIN 3
SENSOR HOUSING	CONNECTOR HOUSING

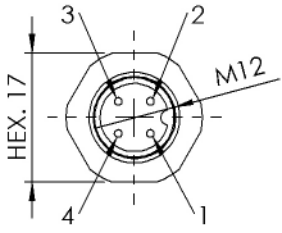

Dimensions : mm



HERMETIC M12 - 4 PINS	
VOLTAGE OUTPUT	PIN
+ EXCITATION	PIN 1
+ SIGNAL	PIN 4
NC	PIN 2
0 VOLT	PIN 3
SENSOR HOUSING	CONNECTOR HOUSING

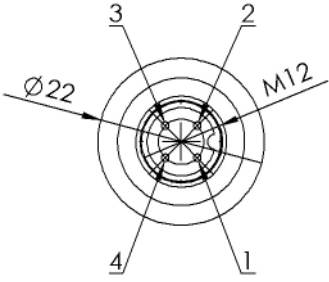

Dimensions : mm



BINDER 723 - 5 PINS	
VOLTAGE OUTPUT	PIN
+ EXCITATION	PIN 3
+ SIGNAL	PIN 2
NC	PIN 4
0 VOLT	PIN 1
NC	PIN 5
SENSOR HOUSING	CONNECTOR HOUSING

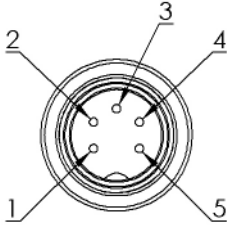

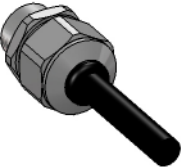

#24 AWG, 4 CONDUCTOR, DOUBLE SHIELD PVC CABLE	
VOLTAGE OUTPUT	CONDUCTOR
+ EXCITATION	RED
+ SIGNAL	GREEN
0 VOLT	WHITE
NC	BLACK
SENSOR HOUSING	SHIELD

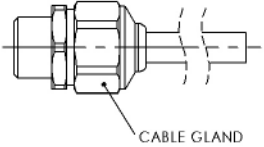

CABLE GLAND



E.F.E.

L'ESSOR FRANCAIS ELECTRONIQUE

16 Rue Porte a Bateaux - 27540 Ivry-la-Bataille - FRANCE

Tel : 33 (0)2 32 22 35 05 - Fax : 33 (0)2 32 36 93 08

www.efe-sensor.com - infos@efe-sensor.com

Agent :