

Compact High Temperature Pressure Sensor



Features

- ➔ All Stainless steel
- ➔ High temperature pressure sensor
- ➔ Thin film technology
- ➔ Optional remote electronic

Applications

- ➔ Oil & gas
- ➔ Aerospace
- ➔ Military
- ➔ Test benches

Operating from -40 up to $+175^{\circ}\text{C}$, the PHT220 serie is dedicated to high temperature pressure measurements. With all stainless steel wetted parts, it is compatible with most media, including corrosive fluids used in automotive, aerospace and energy industries. Equipped with the premium thin film technology developed by EFE, its performances and stability over wide temperature range are excellent. The PHT220 is available with unamplified output (mV/V), compensated in temperature, up to $\pm 0.005\% \text{EM}/^{\circ}\text{C}$, to deliver the best accuracy. Amplified output (Vdc) is also standard, thanks to a high performance and ruggedized electronic module, remote in the cable in a stainless steel package.

Technical specifications

Pressure ranges (FS)	-1/+2bar ; -1/+3bar ; -1/+5bar ; 3bar ; 5bar ; 10bar ; 20bar ; 40bar ; 100bar ; 250bar ; 400bar ; 600bar ; -14.5/+30PSI ; -14.5/+40PSI ; -14.5/+70PSI ; 8000PSI ; 40PSI ; 70PSI ; 150PSI ; 300PSI ; 500PSI ; 1500PSI ; 3000PSI ; 5000PSI
Type	Absolute ; Gage
Type (for ranges > 40 bar)	Sealed Gage
Safe overload	150% FS
Burst pressure	300% FS
Power supply	8 to 16Vdc
Consumption	< 10mA
Insulation	> 1000 MOhms under 50Vdc at ambient temperature
Output at -100%FS (only for \pm range)	0.5Vdc
Output at 0%FS (except ranges \pm)	0.5Vdc
Output at 100%FS	4.5Vdc
Zero and sensitivity settings tolerances	$\pm 50\text{mV}$

Technical Specifications

Amplifier type	Remote electronic, operating from -40 to +125°C, with 1m of cable at each side (standard)
Non linearity and hysteresis combined	±0.25% FS Option : ±0.1% FS
Non repeatability	±0.02% FS typ.
Signal bandwidth	1000Hz @ -3dB Option : Special Adjustment up to 3000Hz @ -3dB
Compensated temperature range	-30 to +150°C Option : 0 to +175°C
Operating temperature range	-40 to +150°C (-40 to +175°C if optional compensation up to 175°C)
Combined thermal zero & sensitivity shifts	±0.02% FS/°C
Constant acceleration in linear vibrations	± 0.02% FS/g (frequency 20-2000Hz, 50g max.)
Mechanical shock	100g ½ sinus 1ms
Electrical protection	Protected against polarity inversion
EMC protection	Compliant to EN61000
Electrical connection up to 150°C	AWG26 Shielded Teflon Cable Ø3.4mm ±0.2, 5 wires Option : MIL-DTL-38999 - 6 pins Receptacle
Electrical connection above 150°C	AWG26, Viton Jacketed Shielded Cable Ø3mm, 4 wires Option : MIL-DTL-38999 - 6 pins Receptacle
Mechanical connection	M14x1.5-4h male Option : 7/16-20 UNJF-3A male - MS33656-4 ; M10x1-4h male with 80° internal cone
Material(s) of wetted parts	Stainless Steel 316L ; Stainless Steel 17-4PH ; Stainless steel 15-5PH
Weight	< 100g without cable
Enclosure protection	IP65 for absolute & sealed gage version

Codification

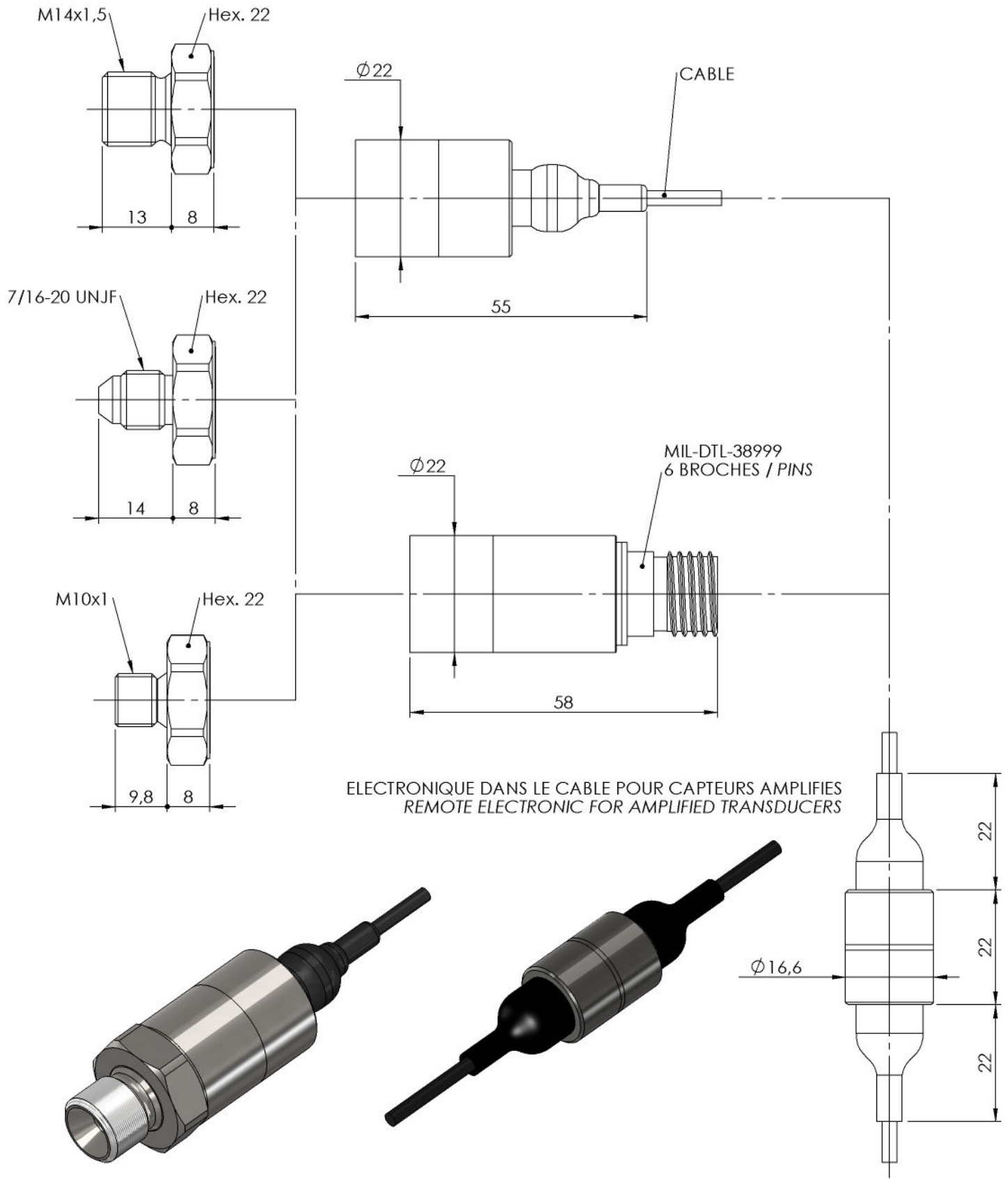

Compact High Temperature Pressure Sensor	PHT22	7	S	10bar	A	01	08/1m	F	1	1	B
Output Signal											
0.5-4.5Vdc unregulated power supply		7									
Material											
Stainless Steels			S								
Range											
Example				10bar							
Type											
Absolute					A						
Gage					G						
Sealed Gage					SG						
Mechanical connection											
M14x1.5-4h male						01					
7/16-20 UNJF-3A male - MS33656-4						10					
M10x1-4h male with 80° internal cone						19					
Electrical connection											
AWG26, Viton Jacketed Shielded Cable Ø3mm, 4 wires							08/1m				
AWG26 Shielded Teflon Cable Ø3.4mm ±0.2, 5 wires							09/1m				
MIL-DTL-38999 - 6 pins Receptacle							20				
Compensated temperature range											
-30 to +150°C								F			
0 to +175°C								G			
Non linearity and hysteresis combined											
±0.25% FS									1		
±0.1% FS									2		
Combined thermal zero & sensitivity shifts											
±0.02% FS/°C										1	
Options											
Special Adjustment up to 3000Hz @ -3dB											B





Dimensions : mm

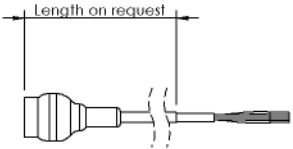

#26 AWG, 4 CONDUCTOR SHIELDED VITON CABLE	
VOLTAGE OUTPUT	CONDUCTOR
+ EXCITATION	RED
+ SIGNAL	GREEN / YELLOW
NC	WHITE
0 VOLT	BLUE / BLACK
SENSOR HOUSING	SHIELD

5 CONDUCTOR TEFLON CABLE	
VOLTAGE OUTPUT	CONDUCTOR
+ EXCITATION	RED
+ SIGNAL	GREEN
0 VOLT	BLACK
NC	WHITE
NC	BLUE
SENSOR HOUSING	SHIELD

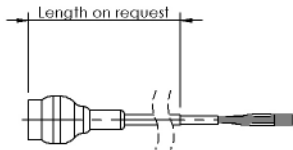
MIL-DTL-38999 - 6 PINS	
VOLTAGE OUTPUT	PIN
+ EXCITATION	PIN 1
+ SIGNAL	PIN 3
- SIGNAL (0 Vdc)	PIN 4
- EXCITATION (0 Vdc)	PIN 2
NC	PIN 5
NC	PIN 6
SENSOR HOUSING	CONNECTOR HOUSING



Agent :

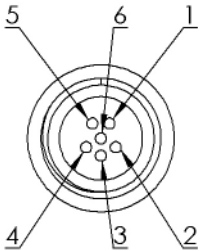

E.F.E.
 L'ESSOR FRANCAIS ELECTRONIQUE
 16 Rue Porte a Bateaux - 27540 Ivry-la-Bataille - FRANCE
 Tel : 33 (0)2 32 22 35 05 - Fax : 33 (0)2 32 36 93 08
www.efe-sensor.com - infos@efe-sensor.com